

Article number: 12727000020100
Description: KLEE-coil 727 000 020.100
M2 Steel

Measures

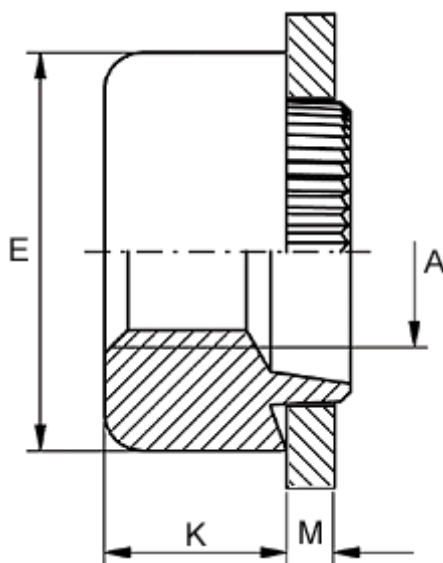

Female thread A	= M2
Height K	= 2.0
Outer diameter E	= 5.0
Plate thickness	= 1.7 to 1.9
Recommended bore diameter +0.05	= 4.0